

The OVERDRIVE

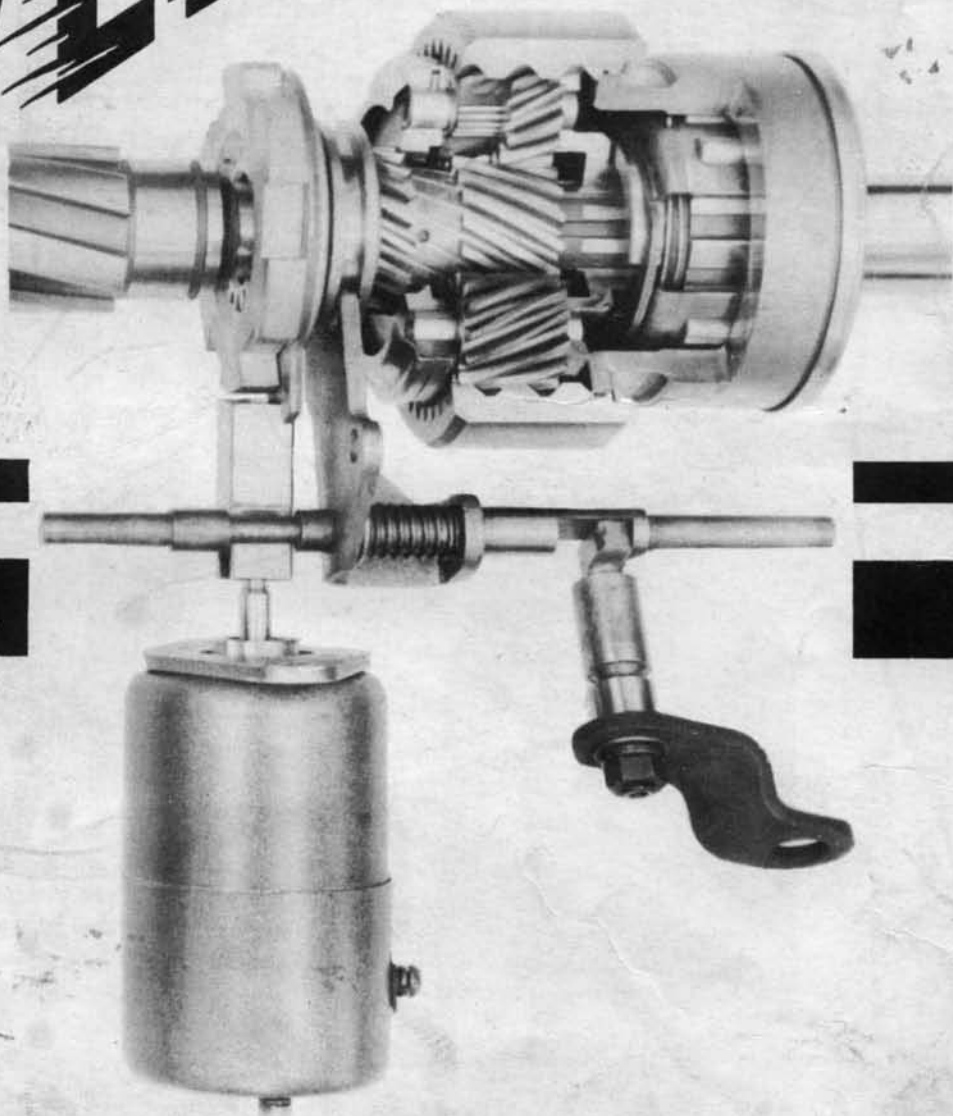

WARNER AUTOMOTIVE PARTS DIVISION
BORG - WARNER CORPORATION
AUBURN, INDIANA

404

PRICE 50¢

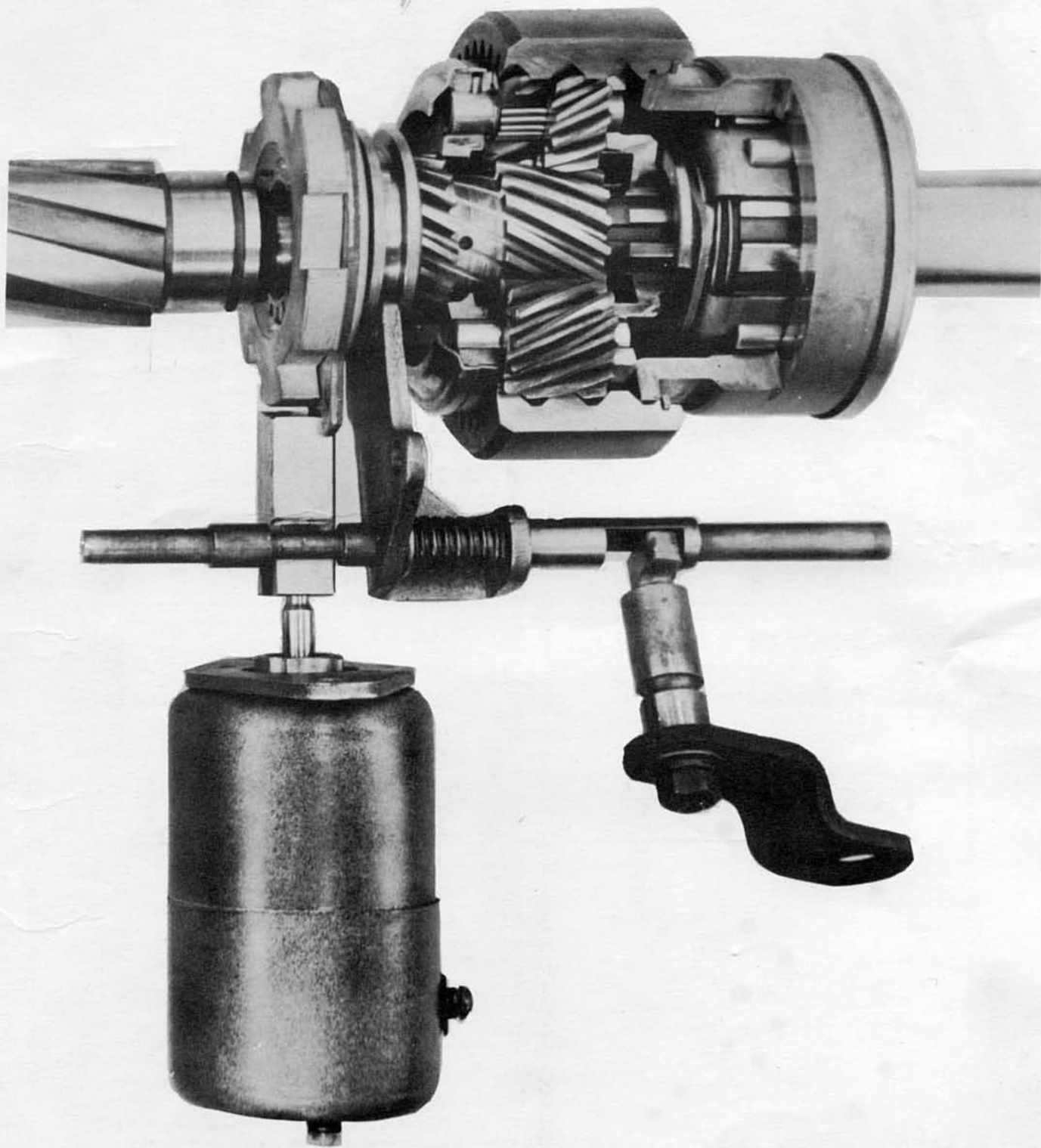

Figure 1.
Working Parts of Overdrive Unit.

INSTRUCTION MANUAL

THE WARNER AUTOMATIC

OVERDRIVE

FOREWORD

Material contained in this Instruction Manual relates only to post-war Overdrive types (Warner R-10 and R-11) as used on the following makes of cars:

Ford	Mercury
Frazer	Nash
Hudson	Packard
Kaiser	Studebaker
Lincoln	Willys

While the actual details of construction may differ among the different car makes and models, the essential working parts are similar, if not identical, and the information contained herein may be considered generally applicable to all cars equipped with these types of Overdrive Units.

TABLE OF CONTENTS

I PERFORMANCE	2-3
1. General	2
2. Comfort	2
3. Operating Economy	2
4. Reduced Engine Maintenance	3
5. Increased Ease of Handling	3
6. Highway Driving	3
7. City Traffic Driving	3
8. Reduced Use of Clutch Pedal	3
II OPERATING PRINCIPLES	4-8
A. MECHANICAL	4
9. General	4
10. Free-wheeling Direct Drive	4
11. Overdrive	4
12. Driver-controlled Downshift (Kickdown)	5
13. Conventional Drive	6
B. ELECTRICAL	6
14. General	6
15. Speed-Controlled Operation	6
16. Driver-controlled Operation	7
17. Locked-out Operation	8
III SERVICE OPERATIONS	8-15
A. TRACING AND CORRECTION OF ELECTRICAL CONTROL TROUBLES	8
18. Overdrive Does Not Engage	8
19. Overdrive Does Not Release	8
20. Will Not Kickdown from Overdrive	9
21. Engine Cuts Out When Kickdown is Attempted	9
B. MECHANICAL FAULTS	9
22. Dash Control Improperly Connected	9
23. Transmission and Overdrive Improperly Aligned	10
24. Improper Reverse Control Parts	10
25. Throttle Switch Improperly Adjusted	10
26. Improper Installation of Solenoid	10
27. Improper Positioning of Blocker Ring	10
28. Insufficient Blocker Ring Friction	11
29. Damaged Roller Clutch Parts	11
C. COMMON CAUSES OF TROUBLE	11
30. Does Not Drive Unless Locked Up	11
31. Overdrive Does Not Engage	11
32. Overdrive Does Not Release	11
33. Does Not Kickdown from Overdrive	11
34. Engine Cuts Out When Kickdown is Attempted	11
35. Does Not Release Lockup	11
D. SERVICING OF OVERDRIVE UNIT	11
36. General	11
37. Disassembly	12
38. Cleaning and Inspection	14
39. Reassembly	14
40. Lubrication	15

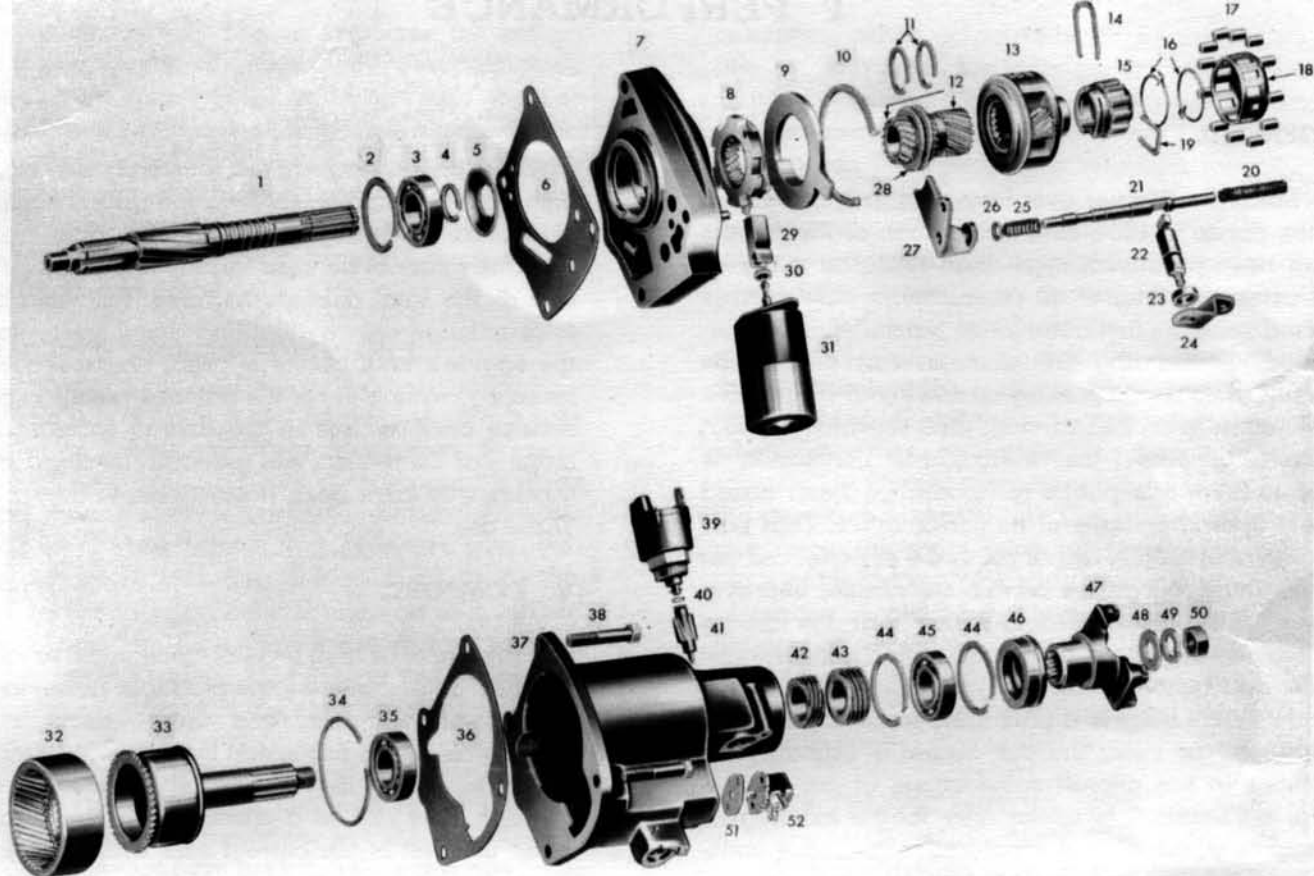

Figure 2.
Exploded View of Overdrive Parts

- | | |
|---|--|
| 1. Transmission Main Shaft. | 27. Manual Control Fork. |
| 2. Snap Ring, Large. | 28. Sun Gear Shift Collar. |
| 3. Main Shaft Rear Bearing. | 29. Pawl. |
| 4. Snap Ring, Small. | 30. Pawl Rod Oil Seal. |
| 5. Oil Baffle. | 31. Solenoid. |
| 6. Adapter Plate Gasket. | 32. Ring Gear. |
| 7. Adapter Plate. | 33. Output Shaft with Clutch Outer Race. |
| 8. Sun Gear Control Plate and Blocker Ring. | 34. Ring Gear Snap Ring. |
| 9. Retainer Plate with Oil Cuff. | 35. Output Shaft Bearing, Front. |
| 10. Adapter Snap Ring. | 36. Housing Gasket. |
| 11. Sun Gear Snap Ring. | 37. Housing. |
| 12. Sun Gear. | 38. Capscrew. |
| 13. Pinion Cage. | 39. Governor. |
| 14. Cage Retaining Clip. | 40. Governor Pinion Snap Ring. |
| 15. Clutch Cam. | 41. Governor Pinion. |
| 16. Roller Cage Spring. | 42. Governor Drive Gear. |
| 17. Clutch Rollers. | 43. Speedometer Drive Gear. |
| 18. Roller Cage. | 44. Snap Ring. |
| 19. Cam Retaining Clip. | 45. Output Shaft Bearing, Rear. |
| 20. Retractor Spring. | 46. Rear Oil Seal. |
| 21. Manual Control Shift Rail. | 47. Universal Joint Flange. |
| 22. Manual Control Shaft | 48. Plain Washer. |
| 23. Manual Control Shaft Oil Seal. | 49. Lock Washer. |
| 24. Manual Control Lever. | 50. Nut. |
| 25. Manual Control Fork Spring. | 51. Lockout Switch Gasket. |
| 26. Manual Control Fork Washer. | 52. Lockout Switch. |

1. GENERAL

a. Since the Warner overdrive was first introduced to the public in 1934, over two million of these units have been produced, more than twice as many as the combined total of all other comparable devices offered since the first automobile transmission was invented. Considering that each overdrive unit was bought at substantial extra cost, without aggressive sales effort in its behalf, and, until recently, without advertising effort, the inescapable conclusion is that its favorable public reception has been based solely upon the merits of its performance. That performance is readily apparent to the experienced car owner, who recognizes certain substantial improvements, not otherwise obtainable, that the device makes possible in the overall operation and performance, and hence in the enjoyment, of the car as a whole. While there is a prevailing tendency to stress "features" as such, the car owner is primarily interested in the overall satisfactions of car ownership; a "feature" is useful only to the extent that it makes a substantial contribution to those satisfactions of comfortable, economical and reliable motoring. While the owners of overdrive-equipped cars are, in general, well acquainted with the improvements that they enjoy in such satisfactions, few know exactly why the overdrive brings these benefits to them, and a brief statement of the fundamental reasons is in order:

b. If it were not for certain basic limitations of the internal combustion engine, there would be no need for the transmission or any of its associated parts. The reasons for these units are well-established, and generally understood. The clutch or its equivalent must be provided because the engine must be first started and running, without load, and then gradually connected to the standing car. Likewise, the usual first and second gears, or their equivalent, must provide special mechanical advantage for the engine which cannot of itself provide the additional pulling capacity required for starting, severe hill-climbing, or the like. However, such conditions actually account for a very small fraction of the car's actual use. Most of the car's total mileage is for straightaway driving, whether in city traffic or upon the open road. For these conditions the driver habitually uses third speed, or high gear, for which use the car manufacturer establishes the relation of engine speed to car speed by choice of the rear axle gear ratio. To meet American standards of performance, a rear axle gear ratio is chosen that, on a typical current model car, may yield a power reserve five times as

great as the power required for steady driving, at 40 mph. This reserve for acceleration and hill-climbing, is available by merely pressing the accelerator; it obviously cannot be used for any important percentage of the total mileage traveled. For most of this total mileage only a relatively small percentage of the engine's total ability is used; and the necessity for ready availability of the balance results in certain serious compromises in the overall satisfactions of motor car ownership, not generally realized by car owners who have been accustomed to accept them. These are:

2. COMFORT.

a. In spite of its high level of mechanical excellence, the best automobile engine produces noise, together with some vibration, and these effects increase sharply as the engine speed increases. Whereas, below 30 mph, they may be scarcely noticeable, above 60 mph, they are, to a critical driver, intolerable in even the best of the current cars without overdrive. Even though this is somewhat offset by the presence of less irritating noise from the wind and road, it is well recognized that power plant noise and vibration are major contributors to driver and passenger fatigue, to an extent which can be appreciated only by comparison with a car from which they have been substantially eliminated.

b. If, for instance, the engine speed can be reduced by 30%, the powerplant noise and vibration is reduced to half, or less. With this reduction, these unpleasant effects apparently disappear, and the riding sensation is almost that of continuously coasting downhill. To accomplish this in a manner acceptable to American standards of performance and handling ease, requires an additional driving ratio, automatically available above slow traffic speeds, in which the car can be driven for miles at a time, and from which the driver, at his own pleasure, can return to the usual "high gear" for purposes of acceleration and hill-climbing. This, in brief, is what the overdrive provides.

3. OPERATING ECONOMY.

a. When the car owner buys gasoline, he may be under the impression that it is for the purpose of driving only the car. He seldom realizes that a substantial portion of it is to overcome engine friction and drive the engine accessories. At 40 mph, it requires 12 hp. to drive a typical car, but without overdrive it re-

quires an additional 18 hp to overcome the power-plant losses. On the other hand, with overdrive these losses amount to only 11 hp. In the first case gasoline must be bought for a total of 30 hp; in the second case, for a total of 23 hp. The difference stays in the owner's pocket. Likewise, the reduced piston speed, as well as the reduced total piston travel, enables many overdrive-equipped cars to run from one oil change to the next without adding oil.

4. REDUCED ENGINE MAINTENANCE.

a. While it is obvious that if the engine travels only 0.7 as far as the car, the intervals between the customary engine repair and service operations will be proportionately extended, it must not be overlooked that the engine also travels only 0.7 as fast, with overdrive operation, and this reduction of destructive forces serves to extend these intervals still further. Especially among those owners accustomed to hard, fast driving, this reduction of engine maintenance is a common experience with overdrive-equipped cars.

The buyer of a new car has a choice of many items of extra equipment that add to the pleasure and convenience of motoring, but the overdrive is the **ONLY** one that pays back its own extra cost by its savings. The luxury of increased comfort and improved performance that it gives is **FREE**.

5. INCREASED EASE OF HANDLING.

a. When a car is equipped with two driving ratios, one for comfortable and economical travel and the other for high activity, or acceleration, it may be expected that these two ratios will be used to drive the car for all but an insignificant part of the car's total mileage. The constantly changing conditions of road and traffic will require frequent changing from one ratio to the other and modern driving conditions require that these changes be made by controls that relieve the driver of effort and attention; the right thing must be done at the right time. Having these changes dictated by the fixed routine of an automatic mechanism is not enough. The device must also comply with the intentions of the driver—it must actually anticipate his requirements. The overdrive controls fulfill these needs as follows:

6. HIGHWAY DRIVING.

a. When the car is operated below a predetermined "cut-in" speed, varying from 20 to 32 mph, according to car make and model, the direct drive is used, making available the acceleration so desirable at lower speeds. As the car speed increases above the cut-in point the overdrive unit will shift into the overdrive ratio, but only when the driver desires no further ac-

celeration; when consciously, or unconsciously, he lifts his foot from the accelerator, whereupon the shift is completed. Thereafter, the overdrive remains in effect until the car speed falls below the "cut-out" point, when the overdrive is released.

b. However, at high speeds, the driver while operating in overdrive may require additional acceleration, beyond that available by opening the throttle wide. His natural impulse is to press the accelerator further, and this act releases the overdrive, making available the full acceleration of direct drive. The direct drive is retained as long as the full acceleration is required; when the driver no longer requires it he unconsciously lifts his foot from the accelerator, whereupon the overdrive is resumed. If the driver so desires, he may retain the direct drive indefinitely by maintaining a small amount of throttle opening. By thus combining the unconscious reflexes of the driver with the automatic mechanism of the overdrive unit, it is possible to endow a mechanical "brain" with "judgment", and still have the entire action subject to the conscious control of a skilled driver.

7. CITY TRAFFIC DRIVING.

a. Much city driving is under conditions which permit speeds of 20-32 mph, with frequent stops. Many drivers are accustomed to start in second gear under such conditions. With overdrive-equipped cars, the driver may start in second gear, accelerate up to the cut-in speed, and, by merely lifting the foot from the accelerator pedal, engage the overdrive-second gear combination, which is approximately the same ratio as the usual third speed. At the first traffic stop, it is merely necessary to release the clutch; the gear-shift lever is not touched. Furthermore, if a special burst of acceleration is needed in a tight traffic spot, the full power of second gear may be had by pressing the accelerator to the floor, resuming the overdrive-second by the usual method of closing the throttle. Most of the benefits of automatic gearshifting are thus had without the usual complicated and expensive automatic transmission mechanism.

8. REDUCED USE OF CLUTCH PEDAL.

a. At speeds below the overdrive cut-in point, the free-wheeling action of the overdrive unit makes it possible to do all gearshifting without releasing the main clutch. Above cut-in speed, it is necessary to release the clutch for shifting gears, and likewise, the clutch must be released when the car is being started from standstill, and whenever it is being brought to a stop.

II OPERATING PRINCIPLES

A. MECHANICAL

9. GENERAL

a. The current production types (**Warner R-10 and R-11**) of overdrive units are similar, the **R-10** being used on the smaller engines, and the **R-11** on the larger engines. Variations of these units are made to adapt them to the various makes and models of cars, but the principal working parts of both types are similar, if not identical, in all variations. Therefore the working parts shown in cut-away assembly (**Figs. 1, 3, 5, & 8**), and in exploded view (**Fig. 2**), are taken as representative of all current overdrive units, whose mechanical operating principles are explained as follows:

10. FREE-WHEELING DIRECT DRIVE.

a. The transmission mainshaft (**Figs. 2 and 3**) extend thru the sun gear and is splined into the pinion cage and roller clutch cam. The latter has 12 cam surfaces, and 12 clutch rollers located against these

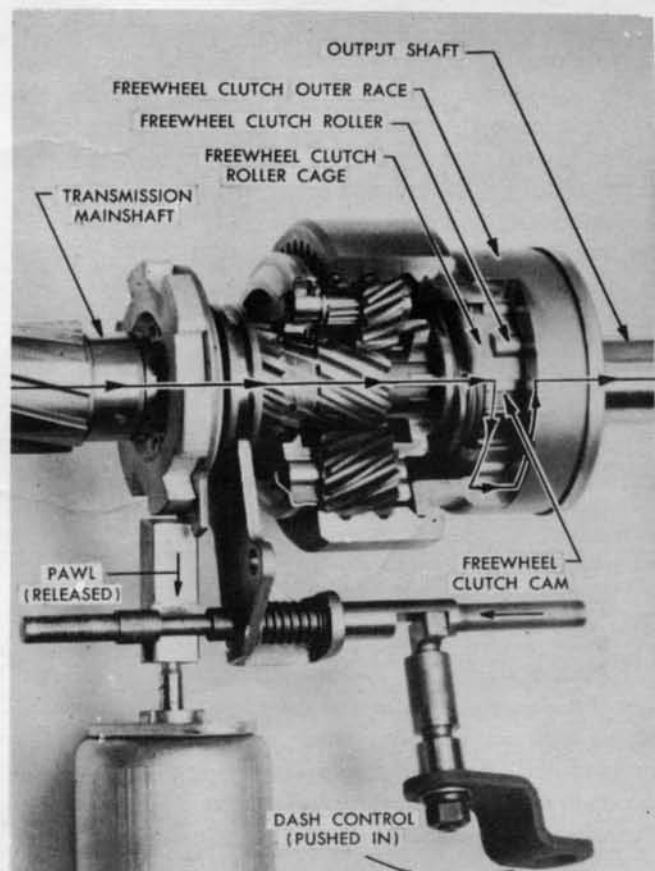

Figure 3.

surfaces by means of the roller cage and the roller cage spring. When a driving torque is applied against the cam, the rollers are forced outward into wedging contact with the outer race (**Fig. 4-a**), thus driving the car. Under such driving conditions, all the overdrive gears and their directly-associated control parts revolve together as a unit.

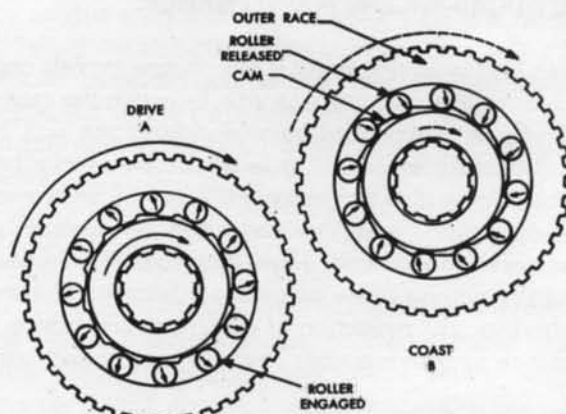

Figure 4.

b. On the other hand, if the throttle is closed, removing the driving force, the rollers release their wedging contact (**Fig. 4-b**), permitting the roller clutch to overrun, with the mainshaft, pinion cage, and engine turning at a slower speed than the ring gear, output shaft, and propeller shaft. Under such conditions, the ring gear will turn faster than the pinion cage, and the sun gear will turn slower than the latter. In fact, the sun gear may turn forward, stand still, or turn backward, depending solely upon the relative speeds of the transmission main shaft, and the output shaft. If the former is turning at exactly 70% of the speed of the latter, (72% in the case of **R-11** type units), the sun gear will stand still; if it turns faster than this, relatively, the sun gear will turn forward; and if it turns slower, the sun gear will turn backward. If the engine is idling with the car moving forward, this reverse rotation may be quite fast.

11. OVERDRIVE.

a. If the sun gear is held against rotation, (**Fig. 5**), the pinion cage, and hence, the engine, will revolve through only 0.7-turn for each turn of the propeller shaft (**Fig. 6**). The action of the control elements involved is as follows:

b. Assuming that the car is being driven with the dash control pushed in (**Fig. 3**), the sun gear control

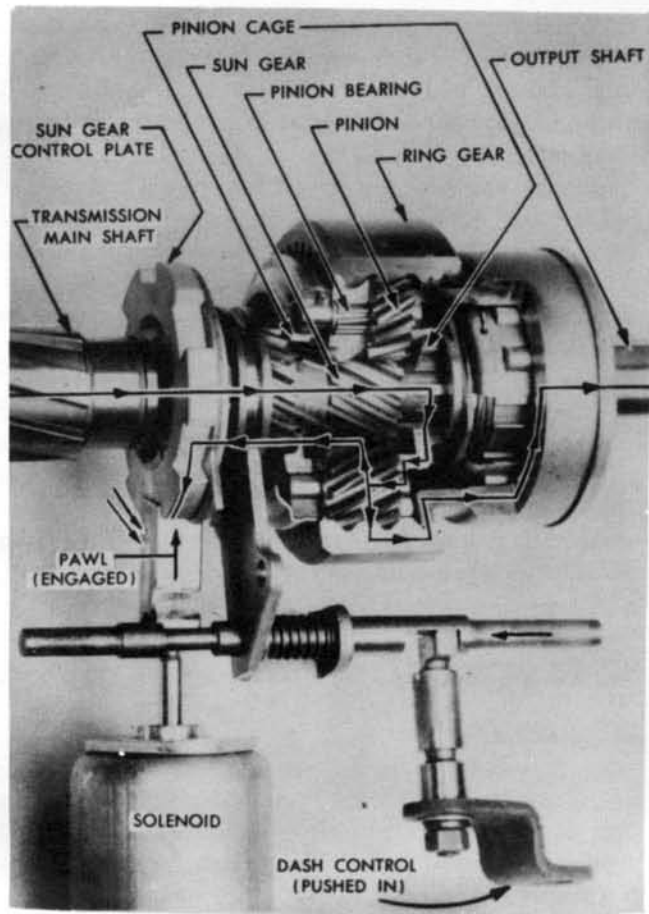

Figure 5.

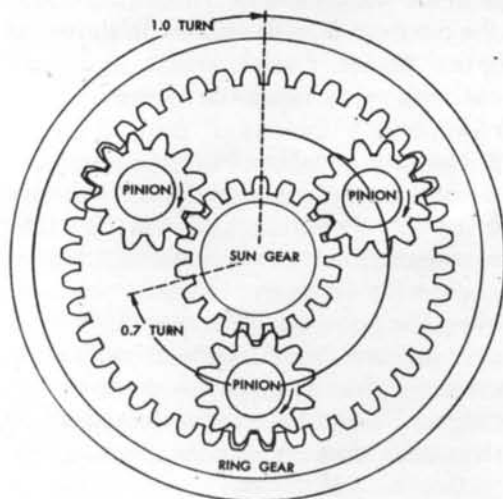

Figure 6.

plate revolves along with the sun gear at the speed of the transmission mainshaft. Under such circumstances, the blocker ring, by its frictional drag upon the hub of the control plate, is rotated into such a position as to latch the control pawl against inward

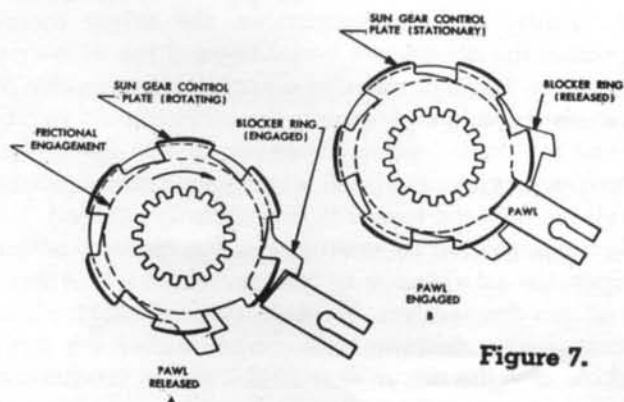

Figure 7.

movement (Fig. 7-a). When the car reaches a predetermined speed (the "cut-in" speed, which varies between 20 and 32 mph, according to car make and model) the governor contacts close, acting through the overdrive electrical circuit to energize the solenoid. The latter sets up a spring pressure against the pawl, tending to push it into engagement. This movement is prevented by the blocker. However, the driver, either unconsciously, or consciously, and according to his own choice, may momentarily close the throttle, whereupon the roller clutch releases, and the engine slows down. At the same time, the sun gear slows down, more rapidly, so that the sun gear passes through the stand-still condition when the engine speed has fallen 30%, and then reverses its motion. Upon the instant of reversal, the blocker ring, moved by its frictional drive from the control plate hub, also rotates slightly in this direction and releases the pawl which snaps into the first notch of the backwardly-rotating control plate (Fig. 7-b). The extreme rapidity of this action insures that the control plate cannot rotate backward more than 1/3 turn at the most; usually, it will be less. This engagement, at nearly perfect synchronism, accounts for the smooth action of this control. Once engaged, under the conditions of normal driving, the overdrive is in action until the car speed falls to a value 3 or 4 mph lower than the cut-in speed, when the governor contacts open, releasing the solenoid, which withdraws the pawl (if throttle is closed), whereupon the condition of free-wheeling direct drive is resumed.

12. DRIVER-CONTROLLED DOWNSHIFT (KICKDOWN).

a. It has been noted, above, that when the overdrive is engaged, the engine only turns 0.7 as fast as when in direct drive. This reduces the power available (excepting at high car speeds) and although this reduced power is usually sufficient for all purposes, there are times when it is desirable to return to direct drive, for more power, without reducing the car speed to the point where the overdrive would normally release.

b. Under such circumstances, the driver merely presses the accelerator pedal beyond the wide-open position. Through suitable electrical controls, this releases the solenoid, urging the pawl toward release from the control plate. However, due to the driving torque reaction, the pawl is held, and cannot move to release until the torque is momentarily relieved. This is accomplished by interrupting the ignition, whereupon the pawl snaps to release, which immediately restores the ignition. When the overdrive has been thus disengaged the roller clutch carries the direct drive, and the driver may hold it in this condition at his pleasure, until he chooses to re-engage overdrive by merely lifting his foot from the accelerator, momentarily. Thereupon the overdrive is resumed, unless the car speed has in the meantime fallen below the overdrive release point.

13. CONVENTIONAL DRIVE.

a. Although the normal procedure is to operate the unit as above, taking advantage of the free-wheeling and the overdrive, there are times, as when descending long, steep grades, where it may be desirable to use the frictional drag of the engine as a brake. Under such circumstances, the overdrive dash control may be pulled out, swinging the control lever (Fig. 8) forward, thus moving the shift rail and shift fork backwards, shifting the sun gear so that the lockup teeth will engage the corresponding teeth of the pinion cage. This causes the entire group of working parts

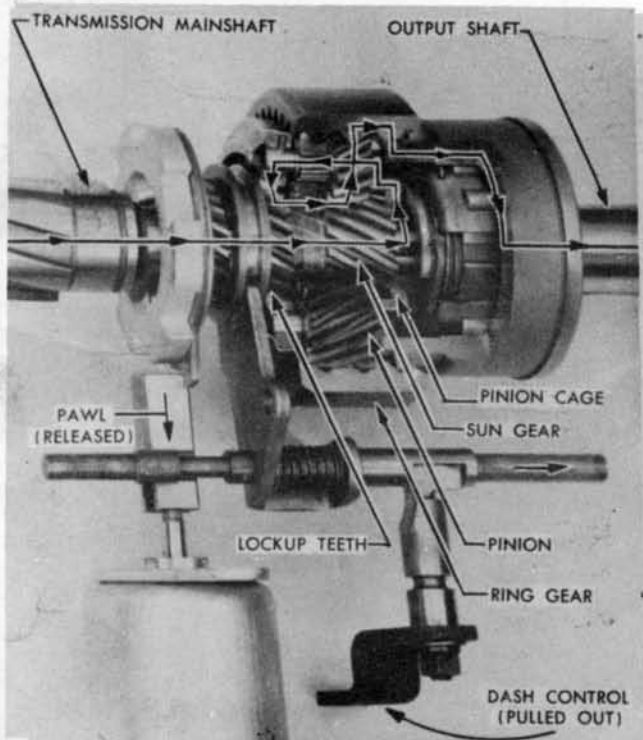

Figure 8.

to revolve as a unit, duplicating in all respects the action of the conventional transmission. In order to thus lock up the unit, if the car is in motion, it is necessary to open the throttle, to assure that all parts revolve together, or to release the overdrive, if engaged, by pressing the accelerator pedal to the floor, pulling out the overdrive dash control at the same time. Thereafter, the car will have the usual conventional drive until the driver chooses to push the overdrive dash control in, which may be easily done at any time.

b. Since the roller clutch will not transmit a reverse drive, it is necessary for the lockup mechanism to be used whenever it is desired to reverse the car. This is done, automatically, by the transmission reverse shift mechanism, which pushes the shift rail to the rear, independently of the overdrive control lever, whenever the transmission is shifted into reverse.

B. ELECTRICAL.

14. GENERAL.

a. While the mechanical structure of the overdrive unit, just described, may be considered the working portion of the combination, its automatic action is controlled entirely by the external electrical control system. This system consists of certain units, connected by a wiring circuit. Whereas, the electrical units are practically identical for the various makes and models of cars with overdrive equipment, there are variations in the wiring circuit. The wiring circuit as shown in the diagram (Fig. 9) applies as shown on 1949 Studebaker, Kaiser, Frazer, Willys and Nash cars (the latter with relay terminals marked "2" instead of "Th Sw", and "1" instead of "Sol"). It applies on 1949 Ford, Mercury and Lincoln cars except that the "Ign" and "Bat" terminals are combined and connected to the ignition switch. It applies on the 1949 Packard cars excepting that the lockout switch is in the circuit between the relay and ignition switch instead of between the relay and governor. 1949 Hudson cars employ a circuit, which while broadly similar in operating principles, is sufficiently different that Fig. 9 does not apply, and the reader is referred to the current Hudson's dealer's service manual, for specific information on this circuit.

15. SPEED-CONTROLLED OPERATION.

a. At low car speeds, the electrical control system is completely inactive. Whenever the car speed reaches the predetermined cut-in point, centrifugal force, acting upon the revolving governor weights, is sufficient to cause the governor contacts to close. This grounds that portion of the circuit connected to one terminal of the relay (marked "Th. Sw."), and if

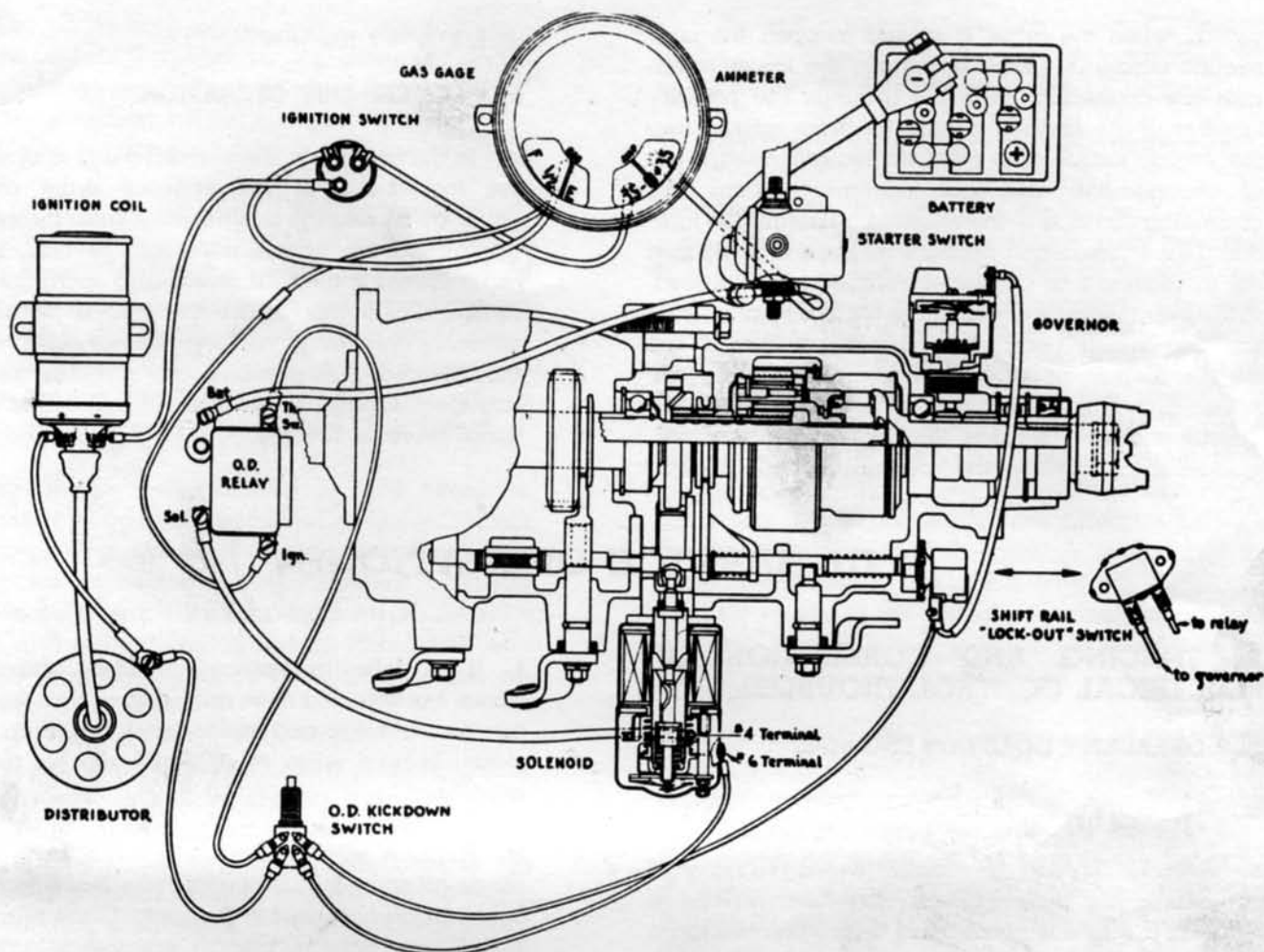

Figure 9.

the ignition switch is turned on, the relay contacts will close. This sends battery current to the solenoid (terminal **No. 4**), energizing the windings of the solenoid, causing the solenoid plunger to move, compressing the inner spring, and urging the pawl toward engagement. Upon completion of the plunger movement, a contact within the solenoid opens, disconnecting the heavy traction-coil winding, leaving the lighter holding-coil winding energized. The solenoid parts remain in this position until the driver closes the throttle, which causes the slowing-down of the sun gear to the reversal point (**11b, above**) and permits the pawl to move into engagement under the pressure of the inner spring. The movement of the solenoid plunger also compresses the outer spring; whenever the car speed falls to a point 4 or 5 mph below the cut-in point, the governor contacts open, releasing the relay, and opening the solenoid circuit, whereupon the outer spring withdraws the pawl from engagement. The circuit then remains inactive until the car speed again reaches the cut-in point.

16. DRIVER-CONTROLLED OPERATION.

a. When operating in overdrive, the driver may require the return to direct drive without reducing the car speed below the cut-out point. If the accelerator pedal is pressed down beyond the position corresponding to wide-open throttle, the stem of the throttle ("kickdown") switch is pressed, thus opening that part of the control circuit between the governor and relay, whose contacts points open, de-energizing the solenoid, the outer spring of which urges the pawl toward release. Due to the fact that the engine is driving the car through the overdrive gear train, the pawl is pinched by the torque reaction and cannot release until the driving torque is removed. This is accomplished as follows:

b. The solenoid stem is provided with a contact which closes whenever the pawl is engaged, grounding the **No. 6** terminal of the solenoid, which is connected to one of the lower terminals of the throttle

switch; when the latter is moved to open the connection across its upper terminals, the lower terminals are connected, and this grounds the primary breaker of the ignition distributor, thus interrupting the engine torque. The pawl immediately snaps out of engagement, and this movement opens the grounding contacts of the solenoid, restoring the ignition. This entire action occurs with such rapidity that not more than 3 or 4 cylinder explosions are missed. In the event that the driver raises his foot slightly from the accelerator pedal the normal position of the throttle switch is restored, thus re-energizing the solenoid, but the pawl cannot re-engage until the throttle is closed to cause the engine to slow down, sufficiently to reverse the rotation of the sun gear,

as previously explained.

17. LOCKED-OUT OPERATION.

a. In the event that the overdrive unit is operated in the locked-out, or conventional drive condition, either by having the dash control knob pulled out, or by shifting the transmission into reverse, the shift rail is moved to the rear, which also opens the lockout switch. Since this opens the circuit between the governor and relay, the latter cannot act to energize the solenoid. This prevents any possible attempt to engage the pawl when operating in either conventional drive or reverse.

III SERVICE OPERATIONS

A. TRACING AND CORRECTION OF ELECTRICAL CONTROL TROUBLES.

18. OVERDRIVE DOES NOT ENGAGE.

a. Turn on ignition switch.

b. Ground "Th Sw" terminal of overdrive relay. If relay does not click, inspect relay fuse; replace if necessary. If fuse is good, check with 6-volt test lamp at both fuse clips. If lamp does not burn at either fuse clip, check wiring between relay and battery or ignition switch. If lamp burns at both fuse clips, and there is no relay click when "Th Sw" terminal is grounded, replace relay. If relay clicks, but solenoid does not, follow procedure 18-f, below. If both relay and solenoid click—

c. Ground the two upper terminals of the throttle switch in turn. If no click results, it indicates defective wire or poor terminal connections between throttle switch and relay. If click results from grounding one terminal, but not from grounding the other, it indicates open throttle switch. Before discarding switch, note 25-b, below. If click results as the two terminals are grounded in turn,—

d. Make similar tests at lockout switch, (excepting on Packard). If open switch is indicated, note 22-a, below, before discarding switch. If click results as the two terminals are grounded in turn,—

e. Ground governor terminal. If no click results, it indicates defective wire or terminal connections between governor and lockout switch (throttle switch on Packard). If relay clicks, replace governor unless governor drive pinion is found to be missing, or governor drive gear is slipping (see 37-k below).

f. If, in following procedure 18-b, above, relay clicks, but solenoid does not, remove wire from "Sol" terminal of relay and replace with test lamp. If latter does not burn when relay clicks, replace relay. If it does burn,—

g. Replace wire to "Sol" terminal of relay, and remove other end of this wire from No. 4 terminal of solenoid and connect to test lamp. Close relay as before. If lamp does not burn, it indicates defective wire. If it does burn, it indicates defective solenoid or connections. Remove solenoid cover, examine solenoid contacts, clean if necessary, reconnect and test again for clicks before discarding solenoid.

19. OVERDRIVE DOES NOT RELEASE.

CAUTION: IF THIS CONDITION ACTUALLY EXISTS, CAR WILL NOT ROLL BACKWARDS, AND ANY ATTEMPT TO FORCE IT TO DO SO MAY SERIOUSLY DAMAGE THE OVERDRIVE UNIT ITSELF.

a. Check for this condition by rolling the car backward by hand, with the gearshift lever in neutral, ignition switch off. If it will roll forward, but not backward, follow procedure 19-h-i, below. If it will roll backward,—

b. Push overdrive dash control knob in; turn ignition switch on and off. If overdrive relay and solenoid do not click, follow procedure 19-h-i, below. If click occurs, it indicates circuit ground between relay and governor, or within the governor or relay (on Lincoln, Mercury, or Ford cars it may mean, also, that the relay contacts are stuck together);

c. Pull overdrive dash control knob out; turn ignition switch on and off. If no click occurs, grounded circuit is indicated between lockout switch and governor, or within the governor; follow tracing procedure **19-e**, below. If click occurs, push dash control knob in;

d. Hold throttle switch open, either by pressing accelerator to the floor, or by pressing the throttle switch stem by hand; turn ignition switch on and off. If no click occurs, grounded circuit is indicated between lockout switch and throttle switch; follow tracing procedure **19-f**, below. If click occurs, ground is indicated between throttle switch and relay, or within one of these units; follow tracing procedure **19-g**, below.

e. With ignition switch turned on and overdrive dash control pushed in, disconnect governor. If click occurs, replace governor. If no click occurs at governor, replace connection, and disconnect governor wire at lockout switch. If click occurs, inspect wire for ground, also switch terminal, which may have been bent into grounding contact. If no click occurs, replace connection, and

f. Disconnect other wire at lockout switch; if click occurs, inspect terminal for ground. If none is found, replace switch. If no click occurs, disconnect and reconnect, in turn, the two upper terminals of the throttle switch. If click occurs as each is disconnected, grounded wire is indicated between lockout switch and throttle switch;

g. If click occurs when one terminal, but not the other, of the throttle switch is disconnected, it indicates a ground at the terminals, or within the throttle switch, in which case it should be replaced. If no click occurs when either terminal is disconnected, disconnect wire from "Th Sw" terminal of relay. If click occurs, it indicates grounded wire between that point and the throttle switch.

h. If no click occurs, when this wire is disconnected, but relay still clicks when ignition switch is turned on and off, inspect terminal for chips or other ground. If none is found, replace relay. With "Th Sw" terminal disconnected, disconnect "Sol" terminal. If solenoid clicks replace relay. If no solenoid click occurs,

i. Remove solenoid. If solenoid can be removed without rotating $\frac{1}{4}$ turn, it indicates improper installation, without properly engaging solenoid stem in pawl (see **26-a-b**, below). Remove solenoid cover, and see if stem has been forced past upper contact spring. Use pawl pulling tool to check pawl for release; if pawl cannot be withdrawn, freely, from engagement, or if the car cannot be pushed forward by hand, with one of the forward transmission speeds engaged, the unit has probably been damaged in-

ternally, and must be repaired or replaced. If no such damage is apparent, and solenoid installation appears proper the solenoid itself may be sticking.

20. WILL NOT KICKDOWN FROM OVERDRIVE.

a. Ground **No. 6** terminal of the solenoid, with engine running. Press throttle switch stem by hand. If engine stops, inspect connection at terminal, and also contacts inside solenoid for proper closing when stem is extended. If engine does not stop, it should stop when one of the lower terminals of the throttle switch is grounded. When the other terminal is grounded engine should stop when the throttle switch stem is pressed. If it does not, replace switch. If the engine does not stop when either of the terminals is grounded, wire or connections are defective, between the throttle switch and the primary terminal of the ignition distributor. (On some cars this connection is made to one of the primary terminals of the ignition coil; be sure that it is **not** made to the terminal connected to the ignition switch.)

b. Occasionally, the upper contacts of the throttle switch will not open. To test for this condition, turn on ignition switch, ground at lockout switch or governor; this should cause the solenoid to click. Press the accelerator pedal all the way to the floor; this should cause a second click as the solenoid releases. If there is no second click, it indicates a defective throttle switch, or that the throttle switch is not being opened (see **25-a-b**, following).

21. ENGINE CUTS OUT WHEN KICKDOWN IS ATTEMPTED.

a. With engine running, press throttle switch stem with hand. If engine stops, disconnect wire from **No. 6** terminal of solenoid and press switch again. If engine does not stop, it indicates a damaged **No. 6** terminal insulator in the solenoid cover, or a defective solenoid. If the engine stops with this terminal disconnected, it indicates either a grounded wire, or a defective throttle switch.

B. MECHANICAL FAULTS.

22. DASH CONTROL IMPROPERLY CONNECTED.

a. Unless the overdrive dash control wire is connected to the lockup lever on the left side of the overdrive housing in such a manner as to move the lever **all** the way back when the dash control knob is pushed in, the lockup switch may be held open, thus disabling electrical control operation. Likewise, it may hold the shift rail in such a position as to interlock the pawl against full engagement, even though

the lockout switch is not held open, resulting in a buzzing noise when overdrive engagement is attempted.

b. To correctly make this connection, loosen binding post at lever, pull dash control knob out $\frac{1}{4}$ in., move lever all the way to the rear, and tighten binding post.

23. TRANSMISSION AND OVERDRIVE IMPROPERLY ALIGNED.

a. The same symptoms as above may also result from misalignment, at assembly, of the overdrive housing to the transmission case, resulting in binding of the overdrive shift rail, so that the retractor spring cannot move the rail fully forward, when the dash control knob is pushed in, and the transmission is not in reverse. Under such conditions, the unit may remain fully locked up.

b. To test for this, be sure that the transmission is not in reverse; disconnect the dash control wire from the lockup lever, and feel the lever for free forward movement. If the lever can be moved forward more than $\frac{1}{4}$ in., it indicates that misalignment probably exists. To correct this, loosen the capscrews between the overdrive housing and transmission case, and tap the adapter plate and overdrive housing until a position is found where the rail shifts freely; tighten capscrews.

24. IMPROPER REVERSE CONTROL PARTS

a. Most overdrive installations provide some arrangement of the transmission controls whereby the shifting of the transmission into reverse also moves the overdrive shift rail backward to lockup the unit, necessary for reverse drive. This usually involves some modification of one or more parts of the reverse shifting mechanism, which are not required with the conventional transmission. Therefore, if the car will not reverse unless the overdrive dash control is pulled out, it is an indication that such special parts were omitted from the assembly.

25. THROTTLE SWITCH IMPROPERLY ADJUSTED.

a. The position of the throttle switch should be so adjusted, by means of the two large nuts which clamp the switch shank, that the accelerator pedal gives a full movement of the switch before the pedal strikes the floor mat. The throttle control rod (to the carburetor) should be so adjusted that the carburetor throttle lever strikes its full open stop just as the pedal touches the throttle switch stem.

b. Occasionally the large nuts which clamp the

throttle switch through the floor board or switch bracket are tightened sufficiently to bend the throttle switch shank, thus preventing free motion of the throttle switch stem. This may usually be remedied by loosening the upper of the two nuts.

26. IMPROPER INSTALLATION OF SOLENOID.

a. If car cannot be rolled backward, under any circumstances and there is no relay click when the ignition is turned on, it probably indicates that the solenoid has been installed directly, without twisting into the bayonet lock between solenoid stem and pawl, thus jamming the pawl permanently into overdrive engagement.

b. If the car will occasionally roll backwards, but not always, (and there is no relay click when the ignition switch is turned on) it may indicate that, upon installation, the bayonet lock was caught, and the solenoid forcibly twisted into alignment with the attaching flange, thus shearing off the internal keying of the solenoid. Under these circumstances, the end of the solenoid stem may not catch in the pawl, and upon release of the solenoid, the pawl will not be withdrawn promptly from engagement, but may simply drift out. If the solenoid stem end has its two flats exactly facing the two solenoid flange holes, it will not withdraw the pawl properly. If the stem can be rotated when grasped by a pair of pliers, it indicates that the internal keying has been sheared. If it cannot be thus rotated, it may be (in the case of Ford cars), that the special station wagon and convertible solenoid has been installed by mistake (this solenoid has the stem flats faced toward the flange holes).

27. IMPROPER POSITIONING OF BLOCKER RING.

a. Occasionally, either in assembly at the factory, or in service operations in the field, the internal parts of the overdrive unit may have been rotated with the solenoid removed, and the pawl withdrawn from its normal location. This may cause the blocker ring to rotate, so that its two lugs are not located with respect to the pawl as shown in Figs. 7 and 21. In other words, the solid portion of the blocker ring may be in alignment with the pawl, which will prevent full engagement of the pawl with the sun gear control plate.

b. To test for this condition, remove solenoid cover, pull dash control knob out, roll car 2 ft. forward. Push dash control in, turn ignition switch on. Then ground "Th Sw" terminal of relay, and watch movement of center stem of solenoid. It should not move more than $\frac{1}{8}$ in. when the solenoid clicks. Then, with the relay terminal still grounded, shift into low gear, and roll car forward by hand. Solenoid stem should then move

an additional $\frac{3}{8}$ in., as the pawl engages fully. These two tests indicate proper blocker action. Unless both tests are met, the blocker ring is probably not in the correct position.

c. Rather than disassemble the entire overdrive unit, this condition may be corrected externally. With transmission in neutral, and the dash control pulled out, move car forward one full turn of the propeller shaft. Then, loosen the two solenoid capscrews as far as possible without removing, and pull solenoid out as far as it will go, and hold it there while the propeller shaft is turned forward about $\frac{1}{8}$ turn. Then push solenoid in, and tighten capscrews. The reasons for this procedure are readily understood from a study of Fig. 7.

28. INSUFFICIENT BLOCKER RING FRICTION.

a. If the overdrive engages with a severe jolt, or noise, probably the blocker ring (Fig 21) has lost its frictional grip upon the hub of the sun gear control plate. This grip should be sufficient to set up a frictional drag of 4-6 lbs. when new, which will fall to 1-1 $\frac{1}{2}$ lbs. when thoroughly broken in. This is measured by holding one lug of the control plate in a soft-jawed vise, with a spring balance hooked into the notch of the nearest blocker lug, and noting the pull required to rotate the blocker **after** it has started moving. While low friction may be corrected by squeezing the blocker ring together for a tighter fit, new parts should be installed if available.

29. DAMAGED ROLLER CLUTCH PARTS.

a. Occasionally, the unit may not drive the car forward in direct drive, unless locked up by pulling the dash control. This may be caused by one or more broken rollers in the roller clutch, the remedy for which is the replacement of the entire set of rollers.

b. This may also be caused by sticking of the roller cage upon the cam. This cage must move freely to push the rollers into engaging position, under the pressure of the two actuating springs.

c. Sometimes this is due to slight indentations, worn in the cam faces by the rollers spinning, remedied by replacement of the cam.

C. COMMON CAUSES OF TROUBLE.

30. DOES NOT DRIVE UNLESS LOCKED UP.

- a. Broken clutch roller (29-a).
- b. Roller cage stuck (29-b).
- c. Clutch cam worn (29-c).

31. OVERDRIVE DOES NOT ENGAGE.

- a. Dash control knob not fully pushed in (17-a).
- b. Fuse blown or missing (18-b).
- c. Open circuit between governor and relay (18-a to 18-g).

- d. Improperly connected dash control cable (22-a).
- e. Shift rail bound by housing misalignment (23-a).
- f. Throttle switch stem stuck (25-b).
- g. Defective throttle switch (18-c).
- h. Defective governor (18-e).
- i. Governor pinion missing (18-e).
- j. Defective solenoid (18-g).
- k. Improperly wired (14-a, Fig. 9).
- l. Blocker ring not in proper position (27-a).

32. OVERDRIVE DOES NOT RELEASE.

- a. Grounded circuit between governor and relay (19-a to 19-h).
- b. Solenoid improperly installed (19-i; 26-a-b).
- c. Defective governor (19-e).
- d. Defective relay (19-h).
- e. Defective solenoid (19-i).
- f. Improperly wired (14-a; Fig. 9).
- g. Defective throttle switch (19-d).

33. DOES NOT KICKDOWN FROM OVERDRIVE.

- a. Throttle switch improperly adjusted (25-a).
- b. Defective throttle switch (20-a).
- c. Open or missing connection between solenoid No. 6 terminal and distributor (20-a; Fig. 9).

34. ENGINE CUTS OUT WHEN KICKDOWN IS ATTEMPTED.

- a. Defective solenoid (21-a).
- b. Grounded wire between solenoid No. 6 terminal and throttle switch (21-a).
- c. Defective throttle switch (21-a).

35. DOES NOT RELEASE LOCKUP.

- a. Improperly connected dash control cable (22-a).
- b. Shift rail bound by housing misalignment (23-a).

D. SERVICING OF OVERDRIVE UNIT.

36. GENERAL.

a. The procedure described below, as it relates to the transmission proper, applies to transmissions manufactured by Warner Gear Division, Borg-Warner Corporation. Where the overdrive unit is attached to a transmission made by the car manufacturer, of a design materially different, such procedure must be modified accordingly. In such cases, the reader is referred to the service manual of the car manufacturer.

b. In the following, the text has been prepared to apply to overdrive unit structures that, while identical in principle, will vary in some detail from one make of car to the other. Where no attention is called to such variations from the parts arrangement shown in Fig. 2, it is assumed that the procedure of disassembly and reassembly is obvious.

37. DISASSEMBLY.

a. Remove transmission and overdrive assembly from the car, and if possible, mount the transmission on a transmission stand or large bench vise. Drain oil from both transmission and overdrive cases.

b. Remove front universal joint companion flange from overdrive unit, using suitable puller if necessary. Do **not** use a hammer to drive the flange off.

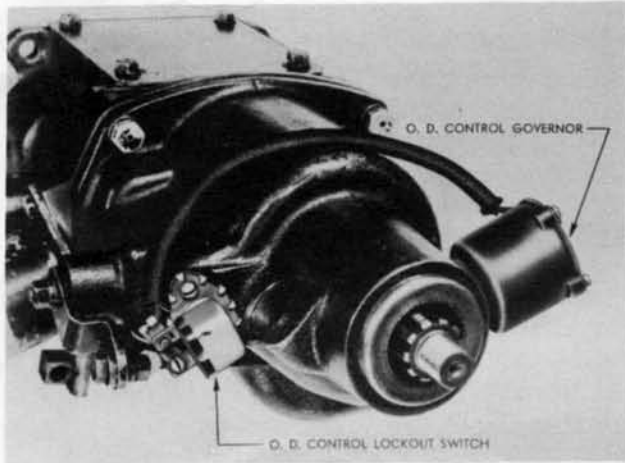

Figure 10.

c. Remove the wire between lockout switch and governor. Remove lockout switch and unscrew governor, using thin wrench or adjustable pliers on the hexagonal surface provided for this purpose. Do **not** use pliers or pipe wrench on the round body of the governor. (Fig. 10).

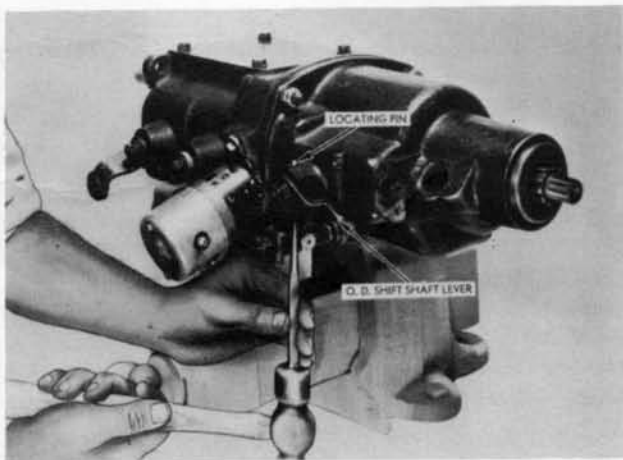

Figure 11.

d. Drive out the tapered pin which holds the manual control shaft in the overdrive case (see Fig. 11). Pull out the control shaft as far as possible to disengage the operating cam from the slotted shift rail.

e. Remove the four cap screws which hold the overdrive housing to the transmission case. (On Lincoln, Mercury and Ford cars use suitable spreader to open ball bearing snap ring.) While removing the overdrive housing, lightly tap the end of the overdrive shaft with a lead or rawhide mallet. Doing this prevents the shaft from coming off with the housing and spilling the clutch rollers.

f. Remove the retractor spring from the housing, the manual control lever from the control shaft, and the control shaft from the inside of the case. The removal of the control shaft oil seal is then easily accomplished.

g. Using a brass drift, drive the overdrive shaft front bearing out of the front of the housing and remove the governor and speedometer drive gears. Removing the rear flange oil seal then permits the removal of the two snap rings and the overdrive shaft rear bearing.

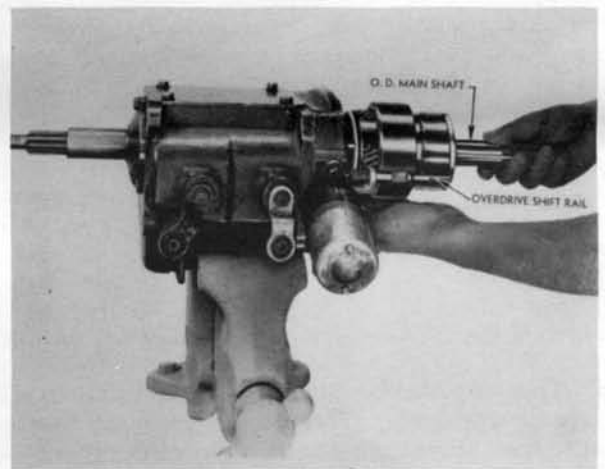

Figure 12.

h. Install one cap screw to hold the adapter plate to the main case. Then remove the overdrive main shaft, catching the clutch rollers in one hand (Fig. 12). Removing the large snap ring will then permit the removal of the ring gear from the output shaft.

i. Removing the retaining clip at the end of the clutch cam permits the removal of the cam and the pinion cage assembly (Fig. 13). To remove the cam from the pinion cage assembly, remove the retaining clip which holds the two units together (Fig. 14). Then remove the sun gear and shift rail assembly (Fig. 15.)

j. Remove the solenoid by taking off the cap screws and lock washers and turning the solenoid clockwise one-quarter turn (Fig. 16).

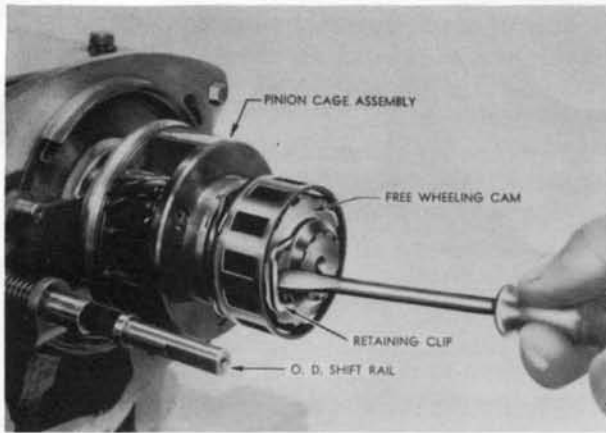

Figure 13.

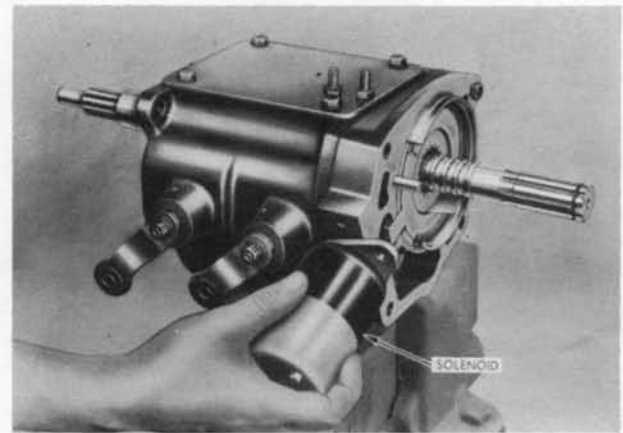

Figure 16.



Figure 14.

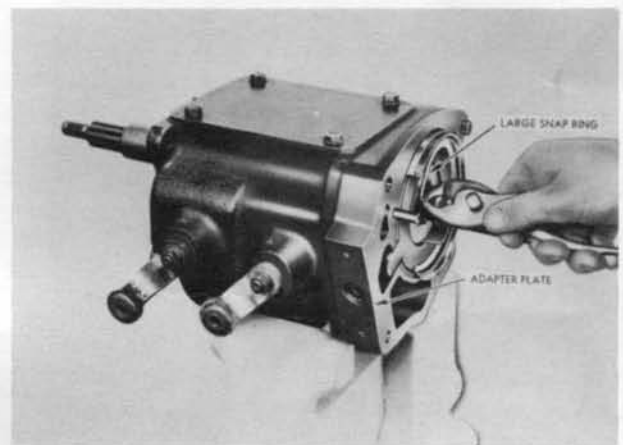

Figure 17.

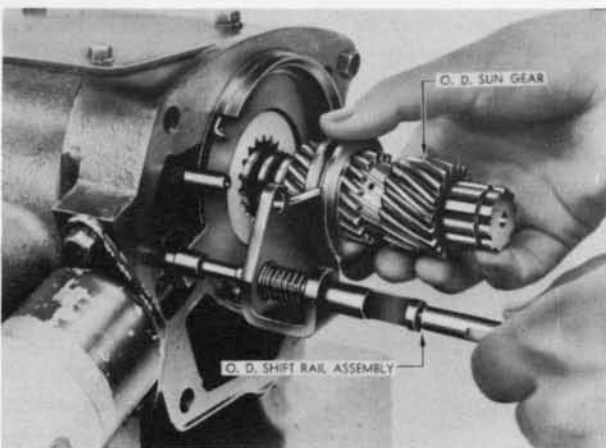

Figure 15.

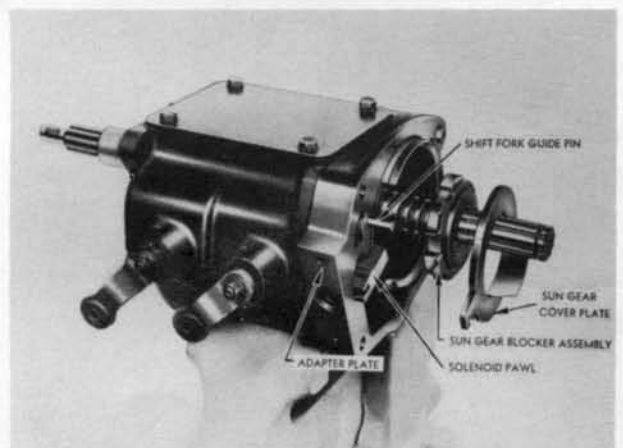

Figure 18.

k. Remove the large snap ring from the adapter plate (Fig. 17). The retainer plate, the sun gear control plate and blocker assembly, and the pawl can then be removed (Fig.18).

l. The procedure for the disassembly of the over-drive-equipped transmission is the same as that for the conventional transmission, with the following exception:

m. Remove the main shaft, adapter plate, gears, and synchronizer assembly from the transmission case as a unit (Fig. 19). After removing the synchronizer assembly and the gears from the main shaft, remove the main shaft rear bearing large snap ring (Fig. 20). Then pull the adapter plate off the main shaft rear bearing and remove the oil slinger from the adapter plate.

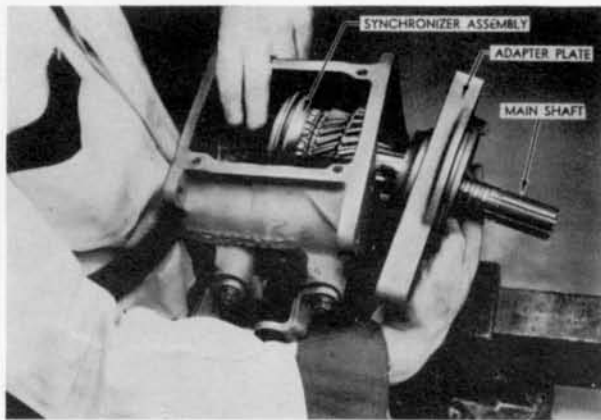

Figure 19.

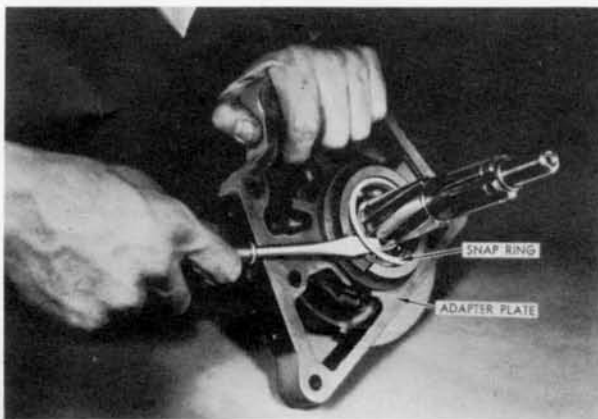

Figure 20.

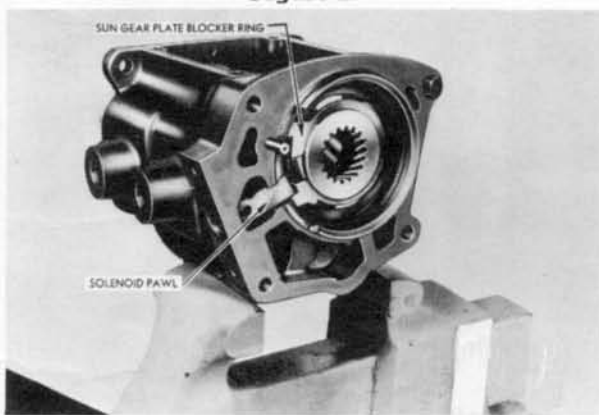

Figure 21.

38. CLEANING AND INSPECTION.

a. As each part is removed from the assembly, wash it in **clean** solvent of a suitable nature, and dry with air blast, or wipe dry. Protect parts from subsequent dirt accumulation.

b. After cleaning, give parts visual inspection for wear or damage. If the unit has been operated with improper or insufficient lubrication, any wear or damage may be detected by visual inspection. Replace any broken parts.

c. If overdrive will apparently engage, but not hold when the power is applied, check to see that the blocker ring is positioned exactly as shown in **Fig. 21**.

d. Roller clutch parts should be carefully inspected. If rollers show surface markings of any kind they should be replaced. If inner surface of outer race shows slight lengthwise indentations, they are normal and do not impair the action of the clutch. However, if the 12 flat surfaces of the cam show such markings, it should be replaced.

39. REASSEMBLY.

a. Upon reassembly, install new gaskets, if available, and also oil seals, if the unit has accumulated any extensive mileage, or if the seals have been damaged in removal.

b. The procedure for the reassembly of the overdrive parts to the main transmission is the same as for the corresponding parts of the conventional transmission with the following exceptions:

c. Place the oil slinger in the adapter plate, insert the main shaft and rear bearing in the adapter plate, and install the large snap ring. After installing the synchronizer assembly and the gears on the main shaft, install the adapter plate and the main shaft assembly in the main case. Then fasten the adapter plate to the case with one cap screw.

d. Insert the pawl with the notched side up. When installing the sun gear control plate assembly and retainer plate, **be sure** that the blocker ring and the pawl are properly positioned (**Fig. 21**). Then install the large snap ring in the adapter plate.

e. Install the solenoid by turning the solenoid counterclockwise one-quarter turn and attach the solenoid to the case with the two lock washers and cap screws.

f. Install the sun gear and shift rail assembly. Attach the clutch cam to the pinion cage assembly with the large retaining clip. Then install the pinion cage and the clutch cam assembly on the main shaft and secure the assembly in place with the small retaining clip.

g. Install the ring gear on the output shaft and lock it in place with the large snap ring. Insert the clutch rollers in the cage using heavy grease to hold them in position. Then, with low gear of the transmission engaged, turning the cage and rollers counterclockwise until the rollers are in their low positions, install the output shaft and ring gear on the pinion cage and free wheeling clutch cam and roller unit assembly,

turning the shaft to the left as it assembles over the clutch rollers.

h. Install the output shaft rear ball bearing with the two snap rings in the overdrive housing. After inserting the speedometer and governor drive gears, install the front ball bearing in the housing. The oil seal should then be installed with suitable oil seal driver.

Note—The oil seal may also be installed with the overdrive housing on the main case.

i. Install the manual control shaft oil seal, control shaft, manual control lever, and retractor in the housing. After removing the cap screw with which the adapter plate has been held on the transmission case, install the overdrive housing. Be sure the dash control conduit bracket is attached to the housing by the lower left cap screw.

j. Push in the manual control shaft to engage the operating cam with the slotted shift rail. Then drive in the tapered pin to retain the manual control shaft in its proper position.

k. Install the lockout switch and the governor, and install the wire which connects them. Fit the companion flange on the output shaft splines, install the companion flange washers and nut, and tighten the nut securely. **Note**—If the companion flange nut is not tightened sufficiently, the speedometer and governor drive gears will rotate on the overdrive shaft, and not drive these units.

40. LUBRICATION.

a. The transmission and overdrive unit are con-

nected with oil passages so that the same oil is used for both. However, certain precautions must be used in the filling, in order that the proper amount of oil may be carried.

b. In making the initial filling, first fill the overdrive unit with the proper oil, until oil runs out the filling hole; then replace plug. Then, fill the transmission with the same oil, until oil runs out the filling hole, and replace the plug.

c. In subsequent filling (at each chassis lubrication), inspect the transmission only, for oil level, and fill as necessary.

d. The manufacturer of the overdrive unit recommends only straight mineral oil, not the "EP" or extreme pressure types of lubricant, which are unnecessary for the overdrive, and may contain ingredients that will corrode or otherwise damage the parts, or form sludge, or contain solid matter in suspension which may stop the oil passages to the pinion bearings, resulting in serious and expensive damage to the unit. **UNDER NO CIRCUMSTANCES MUST A LUBRICANT OF THE HYPOID AXLE TYPE BE USED IN THE OVERDRIVE.**

e. The most satisfactory all-round lubricant for the overdrive is SAE No. 40 engine oil of a good grade. For extremely hard driving in hot climates, SAE No. 50 may be used.

f. Straight mineral oils of the transmission type, SAE No. 80 for all-round use, or No. 90 for hard driving in hot climates, will also be satisfactory.

INSTRUCTION MANUAL

THE WARNER AUTOMATIC OVERDRIVE

WRITTEN AND EDITED BY
WARNER GEAR DIVISION
BORG-WARNER CORPORATION
MUNCIE, INDIANA

WARNER REPLACEMENT PARTS

Manufactured By

WARNER AUTOMOTIVE PARTS DIVISION
BORG-WARNER CORPORATION
AUBURN, INDIANA

Are Distributed to the Jobbing Trade Through

BORG-WARNER SERVICE PARTS CO.

SUBSIDIARY OF BORG-WARNER CORPORATION

310 S. MICHIGAN AVE.

CHICAGO, ILL.

COMPLETE WAREHOUSE STOCKS

Are Maintained at

Atlanta 3, Ga.	81 Currier St., N. E.	Los Angeles 15, Calif.	146 W. 17th St.
Boston 9, Mass.	9 Wallbridge St.	New York 23, N. Y.	311 W. 66th St.
Chicago 16, Ill.	2100 Indiana Ave.	Oakland 8, Calif.	2940 West St.
Dallas 1, Texas	2820 Main St.	Pittsburgh, Pa.	4951 Centre Ave.
Denver 5, Colo.	3041-51 Walnut St.	Philadelphia 30, Pa.	1418 Melon St.
Detroit 11, Mich.	1345 E. Milwaukee Ave.	Portland 4, Oregon	925 N. W. Davis St.
Kansas City 8, Mo.	1916 Grand Ave.		